

Ikelite Digital Housing

instruction manual

#6154.50 for Fujifilm FinePix F50fd



Congratulations on your purchase of an Ikelite Digital Camera Housing. Ikelite has over 40 years of experience in the underwater photographic and lighting market. Our products are designed and built in the USA by Ikelite for both the professional and amateur photographer.

The clear housing permits instant visual inspection of the camera and all sealing surfaces as well as complete monitoring of controls and camera LCD screens.

Ikelite Digital Housings are slightly negative in salt water for stability. This housing has been water pressure tested at the factory. Housing is pressure tested to 200' (60m).

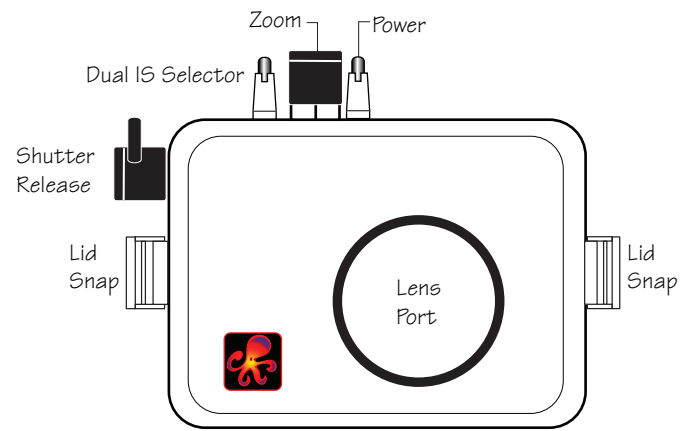

Front View

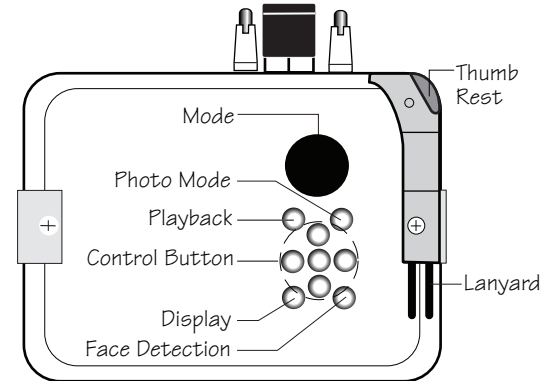

Back View

2

Opening the Housing

1. Lid Snaps have a **Lock**.

To open, push Lid Snap Lock forward and lift as shown. Keep pressure on the Lid Snap so it does not fly open quickly.

Some lid snaps have a lot of spring tension once they go over center, have a firm grip on the lid snap. Lid Snaps may be opened one at a time.

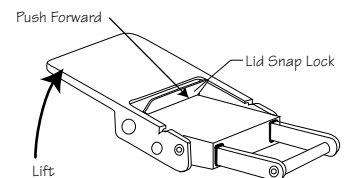

Installing the Camera

1. Remove the back from the housing. The mounting tray for the camera is secured to the housing back. Position the camera on the tray and secure it with the mounting bolt which threads into the camera's tripod socket.

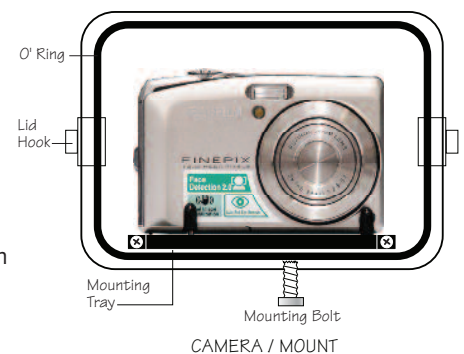

CAUTION:

Some camera tripod socket threads are plastic. The mounting tray bolt is metal. Do not cross thread or over tighten as you may damage the camera tripod socket threads.

2. Pull out on each housing control until it stops. This will get the controls out of the way for installing the camera.

Closing the Housing

1. Place housing face down in your lap or on a flat surface.
2. Check to see that there is an o-ring on the housing back and that it is clean and in its proper location.
3. Guide the back onto the housing. The o-ring should touch the housing all the way around. There should be an even gap all the way around between the housing and the housing back.
4. Lift the lid snaps so they are extended and place the lid snap into the hook on the housing back.
5. To close the housing push down on the lid snaps until they snap into place. Lid snaps on opposite sides of the housing should be closed at the same time. Be sure they are down far enough to engage the lock.

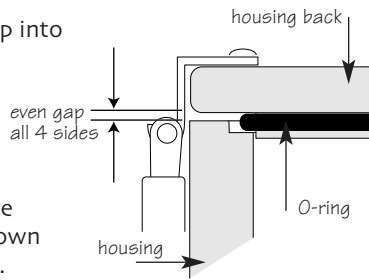
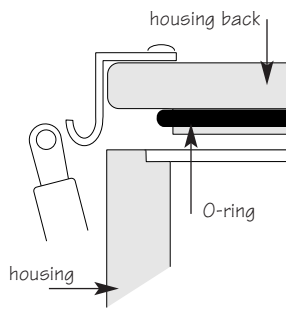

Double check - Once the housing is closed, check the o-ring seal. Check the gap between the housing back and the housing, it should be even all the way around.

Look through the clear plastic back at the o-ring. You should see a darkened area where the o-ring is compressed against the housing back. If you do not see an even black compression seal all the way around the back, open the lid snaps, reseal the housing back and close the lid snaps. Visually check the seal again.

5

Lens Port

Treat the glass in the lens port as a camera lens. After use, rinse and gently dry the lens port to avoid water spotting. To clean use a mild soap solution or lens cleaner.

Do not use alcohol or window cleaner on the Lens Port.

The Wide-Angle Adapter #9306.81 is required to mount the #6420 Ikelite W-20 Wide-Angle Lens and other manufacturers (67mm) screw thread style wide-angle lenses. Bayonet mount Wide Angle Accessory Lenses cannot be used due to extreme vignetting.

The 67mm style lenses can be secured onto the Wide-Angle Adapter above or below water as they are designed to have water between the front of the port and the accessory lens. Make sure no air bubbles are trapped between the port and the accessory lens. Any vignetting that occurs can be eliminated by zooming the camera lens slightly. The camera's built-in flash cannot be used with wide angle lenses. The front of the lenses are so large they block the camera's flash. To properly light subjects when using a wide angle lens an external strobe should be used. Due to the wide-angle of coverage of these lenses, the DS125 Substrobe is recommended or two DS51 Substrobes.

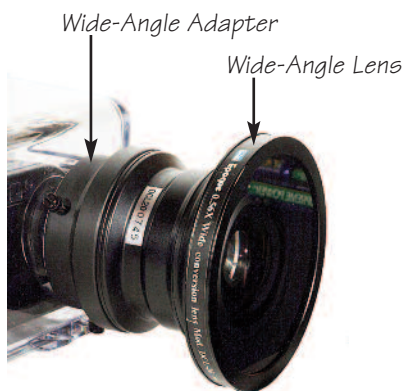

7

Checking Controls

Once the housing has been closed, push the controls back into place. Make sure they line up with the camera's controls.

Turn Camera On

Turn the camera on and operate each of the housing controls to get a feel for using the camera in the housing. Take a few pictures above water with the camera in the housing.

Lubricants

1. Ikelite provides silicone lubricant with the housing. We recommend you use only Ikelite lubricant on Ikelite products as some other brands may cause the o-ring to swell and not seal properly.
2. Use only enough lubricant to lightly cover control shafts and o-rings. Wipe off any excess lubricant with a clean cloth. Lubricant is not a sealant, it is used to reduce friction. Excessive lubricant can collect sand and dirt which may interfere with proper sealing.

CAUTION

Never use spray lubricants as the propellant ingredient can cause the plastic housing to crack.

6

Diffuser & Deflector Installation

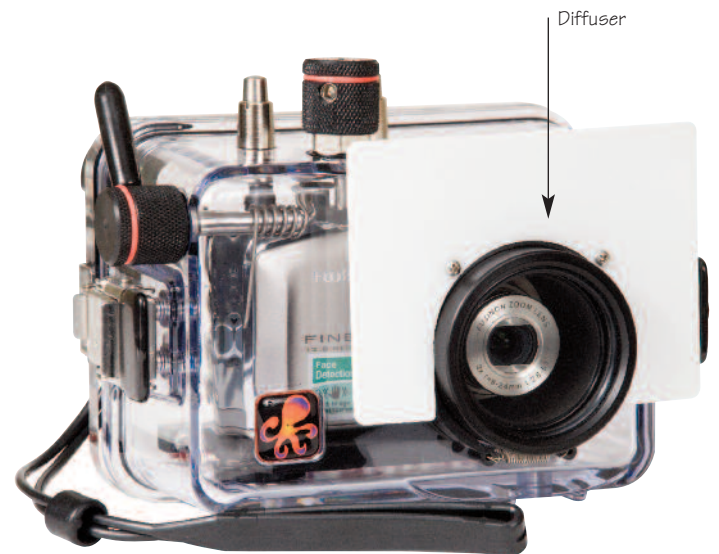

Housing shown with Diffuser installed.

8

Diffuser and Deflector cont.

A diffuser and deflector are included with the housing. The diffuser is white transparent plastic. The deflector is also white but is not transparent and has a decal on the front.

To install the diffuser or deflector spread the port clamp at the spring end and slide over the lens port. The white plastic should be placed in front of the camera flash. The port clamp should be pushed back against the front of the housing.

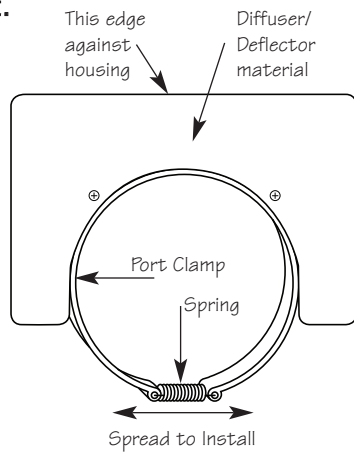

Diffuser

The diffuser should be installed when using the camera's built in flash. When shooting with the camera's built-in flash at approximately 2 feet (0.6 m) or less, the lens port on the housing may block a portion of the light from the camera's built-in flash, creating a shadow in the lower left of the photo. If this occurs, zoom the lens slightly to eliminate the shadow. (You can test this above water)

Deflector

The deflector should be installed when using an external strobe such as the DS51 or DS125 Substrobe and EV Controller. The deflector will redirect the camera's flash to the EV Controller which controls the external strobes output.

9

Optional Accessories

Back O-ring #0109

O-rings last for several years if properly maintained. (See maintenance) Always carry a spare.

UR/Pro Filter (Blue Water) #644132

The UR/Pro underwater color correcting filter is designed to restore some of the warm colors filtered out by the water. For available light use only, not recommended for use with flash.

Green Water Filter #644172

Enhances contrast and alters the color of green water to give your subject a rich, natural tone. For available light only, not recommended for use with flash.

Use the EV Controller with a DS Substrobe

The EV Controller provides 10 manual power settings in 1/2 stop increments for the DS51 or DS125 Substrobes. The EV Controller has a built-in slave which can be triggered by the camera's built-in flash.

Substrobe Packages available

- #3944.47 SubStrobe DS51 with EV Controller & Strobe Arm
- #3944.54 SubStrobe DS51 with EV Controller & Ball Socket Arm
- #3944.77 SubStrobe DS125 with EV Controller & Ball Socket Arm

Optional Accessories Continued



Substrobe DS51

The Substrobe DS51 covers the equivalent of a 28mm lens. It is the ideal choice when using only the camera lens or the camera lens with a macro accessory lens.

Substrobe DS125

The Substrobe DS125 covers the equivalent of a 18mm lens, 100 degrees. It is the ideal choice when using accessory wide angle lenses greater than 28mm.

11

Maintenance

The Ikelite Digital Housing should be given the same care and attention as your other photographic equipment. In addition to normal maintenance we recommend that the housing be returned to Ikelite periodically to be checked and pressure tested.

1. **Do Not** leave the camera and housing in direct sunlight for prolonged periods. Heat may damage the camera.
2. **Do Not** ship the camera in the housing.
3. Before using the housing, always check the tightness of the **set screw** in each control knob. Check each **control gland** to make sure they are tight. There is a slight chance that either could vibrate loose during travel.
4. Keep the back o-ring clean and lightly lubricated. To lubricate remove the o-ring from the back. Put a small amount of Ikelite lubricant on your fingers. Draw the o-ring through your fingers to apply a light coating of lubricant. Only apply enough lubricant to make the o-ring feel slick. **Do Not stretch the o-ring.** This light coating of lubricant will help to keep the o-ring from drying out and will help to show a dark sealing line when the housing back is properly sealed.
5. Keep the area where the o-ring fits and the sealing surface of the housing clean.
6. Rinse the housing exterior in fresh water after each salt water use. Dry with a soft cloth. Dry lens port to eliminate spotting. After several uses in salt water soak the housing in a mild soap solution, rinse and dry before storage. When storing the housing, remove the back o-ring, lightly lubricate and place in a plastic bag. Place the plastic bag with o-ring inside the housing for safe keeping.

CAUTION

Never use spray lubricants as the propellant ingredient can cause the plastic housing to crack.

12

Control Maintenance

Ikelite controls are designed to provide years of reliable service with minimal maintenance.

1. Push button controls require no maintenance other than rinsing in fresh water after saltwater use. If a push button control becomes difficult to push or if it sticks when depressed, soak the housing in luke warm fresh water. After a few minutes operate the push button. If this does not correct the problem, return the housing to Ikelite for maintenance.
2. Some of the controls have long shafts. These controls can be

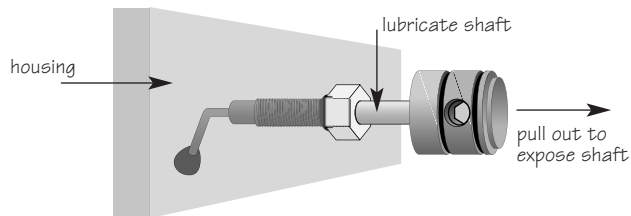

pulled out, exposing the shaft (see drawing).

To lubricate the control, gently pull on the knob until the stainless steel shaft is exposed. Lightly lubricate the shaft, then move the shaft in and out several times. This will lubricate the x'ring in the Ikelite control gland. This should be done before using the housing after a prolonged storage period, or once a week when the housing is in use.

continued on next page

13

General Tips

1. Due to the power required to operate the camera, flash, and LCD screen it is a good idea to start each dive with a fresh set of batteries.
2. Some cameras reset their flash to AUTO when the camera is turned on. If you prefer another setting be sure to select it.
3. As soon as you enter the water, take a moment and check the housing to see that it is properly sealed.
4. Next, check to see if there are any bubbles on the face of the lens port. If there are, take your finger and remove them. If there are bubbles on the lens port they can produce soft focus spots in your photographs.
5. If you use the housing Zoom control, make sure to move it back to the center position. If the housing Zoom control is pushing the camera zoom lever to either side the camera will not function.

15

3. Some of the controls have a short shaft and cannot be pulled out exposing the shaft for lubrication. In the unlikely event one of these controls sticks or becomes difficult to operate you can remove the control from the housing and lubricate it, or return the housing to Ikelite for maintenance. To remove the control, loosen the set screw in the knob (allen wrench required); remove the knob. If there is salt or dirt build-up on the exposed control shaft, clean the shaft. Open the housing and gently slide the control shaft out of the control gland. Clean and lightly lubricate the shaft, including the end of the shaft. Slide the shaft back into the control gland and gently slide it back and forth a few times without fully removing the shaft from the gland. Replace the knob, NOTE the flat area on the shaft, the set screw in the knob should tighten down against the flat area on the control so the knob does not turn on the shaft.

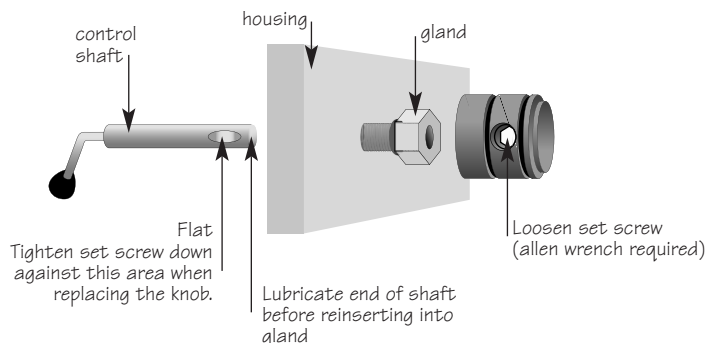

14

Photo Tips

1. The number one rule in underwater photography is eliminate as much water between camera and subject as possible. Get as close as you can to the subject, then use the zoom. If you are using flash, subjects beyond 6 feet (1.8m) will not have much color.
2. Digital cameras have a slight lag time between when you press the shutter release button and the camera actually takes the picture. Hold the camera steady a second or two after pressing the shutter release button.
3. Do not shoot down on subjects as they will quite often blend into the background and be difficult to see in the photograph. Shoot subjects straight on or shoot up at a slight angle using the blue water as a contrasting background.
4. Underwater flash is used to restore the warmer colors filtered out by the water as well as to illuminate the subject. When photographing underwater, set the camera to use flash on every shot. If the camera's flash is set to AUTO and the sun is behind your subject, the camera may see enough light that it does not fire the flash. With the sun behind the subject the subject is shaded (dark) and needs flash for a good exposure.

16

5. Since opinions vary on what is the correct exposure you may want to adjust your camera for what you like exposure wise. Many cameras allow you to adjust both available light and flash exposure with an EV control.
6. Many photographers transfer their images to the computer where they can fine tune the appearance of the image. Many of the image manipulation programs make you think you can magically correct any image taken and make a good picture. One thing to remember when using image manipulation programs, if the image is overexposed much of the color is missing. If the color is missing you cannot adjust it. If images are underexposed some color and detail may be there, it is just dark and you can adjust it to some degree. So if you error in exposure it is better to have the image slightly underexposed than over exposed.

Ikelite Limited Warranty

All Ikelite products are warranted against any manufacturing defects for a period of one (1) year from the date of purchase. Defective products should be returned prepaid to Ikelite. Ikelite will, at its discretion, repair or replace such products, and will return to customer prepaid. All other claims, of any nature, including but not limited to bulb failure are not covered. Except as mentioned above, no other warranty expressed or implied, applies to this Ikelite product.

Returning Products for Service

Ikelite is most interested in performing any service to assure that all products perform as intended. For repair or service, return the product to the address below with your name, address, phone number and a brief description of the problem. Evidence of purchase date must be provided to obtain warranty service.

**Ikelite Underwater Systems
50 W 33rd Street
Indianapolis, IN 46208 USA**

317-923-4523

**email: ikelite@ikelite.com
www.ikelite.com**